

# LED Shadow™

## TFX-UVLED

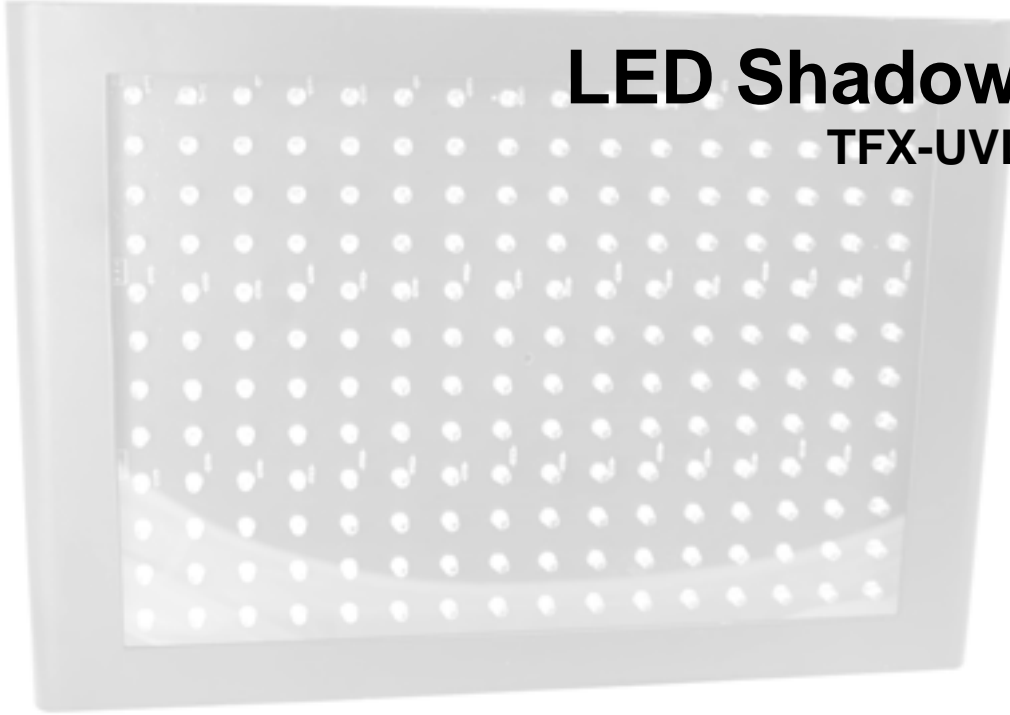

USER MANUAL

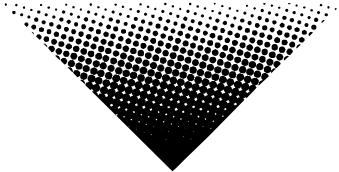

CHAUVET, 3000 N 29<sup>th</sup> Ct, Hollywood, FL 33020 U.S.A  
(800) 762-1084 – (954) 929-1115  
FAX (954) 929-5560  
[www.chauvetlighting.com](http://www.chauvetlighting.com)

---

# Table of Contents

---

<b>1. BEFORE YOU BEGIN.....</b>	<b>3</b>
UNPACKING INSTRUCTIONS.....	3
CONTACT US.....	3
IMPORTANT SAFETY INFORMATION.....	4
<b>2. INTRODUCTION .....</b>	<b>5</b>
FEATURES.....	5
DMX CHANNEL SUMMARY.....	5
PRODUCT OVERVIEW.....	6
<b>3. SETUP .....</b>	<b>7</b>
AC POWER .....	7
MOUNTING .....	7
FIXTURE LINKING.....	8
<i>Data Cabling</i> .....	8
DMX Data Cable.....	8
Cable Connectors.....	8
3-Pin to 5-Pin Conversion Chart .....	9
SETTING UP A DMX SERIAL DATA LINK .....	9
STANDALONE/MASTER-SLAVE FIXTURE LINKING .....	9
<b>4. OPERATING INSTRUCTIONS.....</b>	<b>10</b>
STANDALONE MODE .....	10
<i>Single-Fixture Mode</i> .....	10
<i>Master-Slave Mode</i> .....	10
Setup .....	10
<i>Dipswitch Options</i> .....	10
DMX CONTROL MODE.....	11
<i>Configuring for DMX control</i> .....	11
<i>Setting the DMX address</i> .....	11
DAISY CHAIN (SERIAL DATA LINK).....	11
<b>5. APPENDIX.....</b>	<b>12</b>
DMX PRIMER.....	12
RETURNS PROCEDURE .....	12
CLAIMS .....	12
MAINTENANCE .....	12
BINARY & DMX DIP-SWITCH ADDRESSING.....	13
BINARY ADDRESSING QUICK REFERENCE CHART .....	14
DMX CHANNEL VALUES .....	15
TECHNICAL SPECIFICATIONS.....	16
TECHNICAL SUPPORT .....	16

©CHAUVET, 2006, All Rights Reserved

Information and specifications in this User Manual are subject to change without notice. CHAUVET assumes no responsibility or liability for any errors or inaccuracies that may appear in this manual.

# 1. Before You Begin

---

## Unpacking Instructions

Immediately upon receiving a product, carefully unpack the carton, check the contents to ensure that all parts are present, and have been received in good condition. Notify the shipper immediately and retain packing material for inspection if any parts appear damaged from shipping or the carton itself shows signs of mishandling. **Save the carton and all packing materials.** In the event that a fixture must be returned to the factory, it is important that the fixture be returned in the original factory box and packing.

**Note:** If you should require sending any items back to CHAUVET, call CHAUVET for a (RMA) Return Merchandise Authorization number. The factory will not allow any shipments without an RMA.

### Your shipment includes the following:

- 1 x LED Shadow™ TFX-UVLED
- 1 x Power cable
- 2 x Flush Mount Brackets with screws
- Warranty Card
- Users Manual

## Contact Us

### World Wide

**General Information** Chauvet Lighting  
3000 North 29<sup>th</sup> Court  
Hollywood, FL 33020  
voice: 954.929.1115  
fax: 954.929.5560  
toll free: 800.762.1084

**Technical Support** Chauvet Lighting  
3000 North 29<sup>th</sup> Court  
Hollywood, FL 33020  
voice: 954.929.1115 (**Press 4**)  
fax: 954.929.5560 (**Attention: Service**)

**World Wide Web** [www.chauvetlighting.com](http://www.chauvetlighting.com)

## Important Safety Information



This product is designed for professional use. It is not intended for use in a household environment. This product presents risks of lethal or severe injury due to fire and heat, electric shock, ultraviolet radiation, lamp explosion, and injury from falls. **Read this manual** before installing or powering the fixture, follow the safety precautions listed below and observe all warnings in this manual and on the fixture. If you have any questions about how to operate the fixture safely, please contact CHAUVET.

### Protection against Electric Shock

- Always disconnect from AC power source before servicing or replacing lamp or fuse and be sure to replace with same lamp source.
- All Class I fixtures must be connected to circuits with a suitable Earth Ground.
- To prevent risk of fire or shock, do not expose fixture to rain or moisture. Make sure there are no flammable materials close to the unit while operating.
- Do not operate the fixture if covers are open or if any internal component is missing or damaged: an unshielded discharge lamp emits dangerous UV radiation that can cause burns and eye damage.
- Make sure power cord is never crimped or damaged.
- Never disconnect power cord by pulling or tugging on the cord.

### Protection against Fire & Burns

- This product is designed to be used with very specific lamp(s). Use of any other type of lamp not stated in this manual may create a fire hazard due to possible risk of lamp explosion. Using the wrong type of lamp in this product VOIDS the warranty.
- Always make sure that you are connecting to the proper voltage and that the line voltage you are connecting to is not higher than that stated on decal or rear panel of the fixture.
- The unit must be installed in a location with adequate ventilation, at least 50cm from adjacent surfaces. Be sure that no ventilation slots are blocked.
- Maintain a minimum distance of 1 meter (3.28 feet) from combustible materials.
- Allow this product to cool for a minimum of 15 minutes before opening, handling or removing the lamp in this product.
- Maximum ambient temperature is Ta: 40°. Do not operate fixture at temperatures higher than this.

### Protection against exposure to (UV) Ultraviolet Radiation

- Avoid direct eye exposure to lamp while it is on.
- Do not operate the fixture if covers are open or if any internal component is missing or damaged.

### Protection against Injury to persons

- Secure fixture to fastening device using a safety chain.
- A hot lamp is an explosion hazard. Do not open fixture for a minimum of 15 minutes after switching off. Wear eye and hand protection when re-lamping.
- Fixture surface may reach temperatures of up to 160° C (320° F). Handle fixture after it cools.
- In the event of serious operating problem, stop using the unit immediately. Never try to repair the unit by yourself. Repairs carried out by unskilled people can lead to damage or malfunction. Please contact the nearest authorized technical assistance center. Always use the same type spare parts.

#### **Caution!**

***There are no user serviceable parts inside the unit. Do not open the housing or attempt any repairs yourself. In the unlikely event your unit may require service, please contact CHAUVET.***

# 2. Introduction

---

## Features

- 3-channel DMX-512 LED UV blacklight
- Blackout/static/dimmer/strobe
- Built-in automatic programs
- Adjustable flash rate, dimmer and static via stand-alone
- Automatic built-in programs with sound activation
- Linkable with LED Techno Strobe™ & LED Techno Strobe RGB™ in stand-alone
- Coverage up to 15ft x 30ft
- Low power consumption
- Additional power output for daisy chaining units together

## DMX Channel Summary

1		2	3	DMX Channel (Columns)
Dimmer	000~029	Intensity 0% ~ 100%	Intensity 100% ~ 0%	
Preset Programs (1 ~ 6)	030~209	Speed Slow ~ Fast		
Sound Mode	225~255	No Function		
CONTROL MODES & OPTIONS (Rows)				

For a detailed view of DMX values turn to the Appendix section in this manual. Control mode parameters are set by DMX values in Channel # 1.

# Product Overview

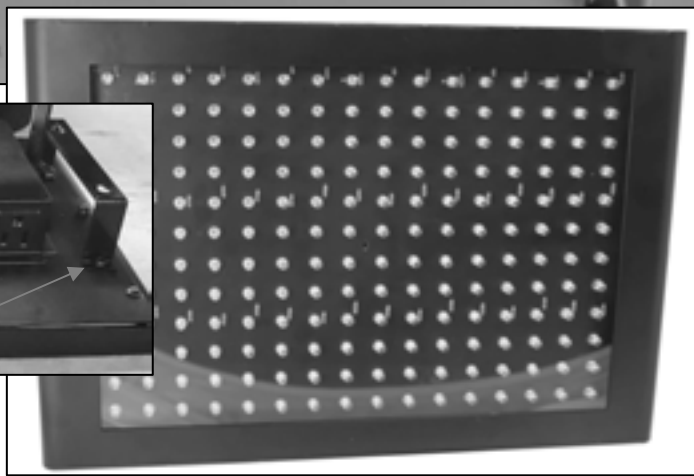
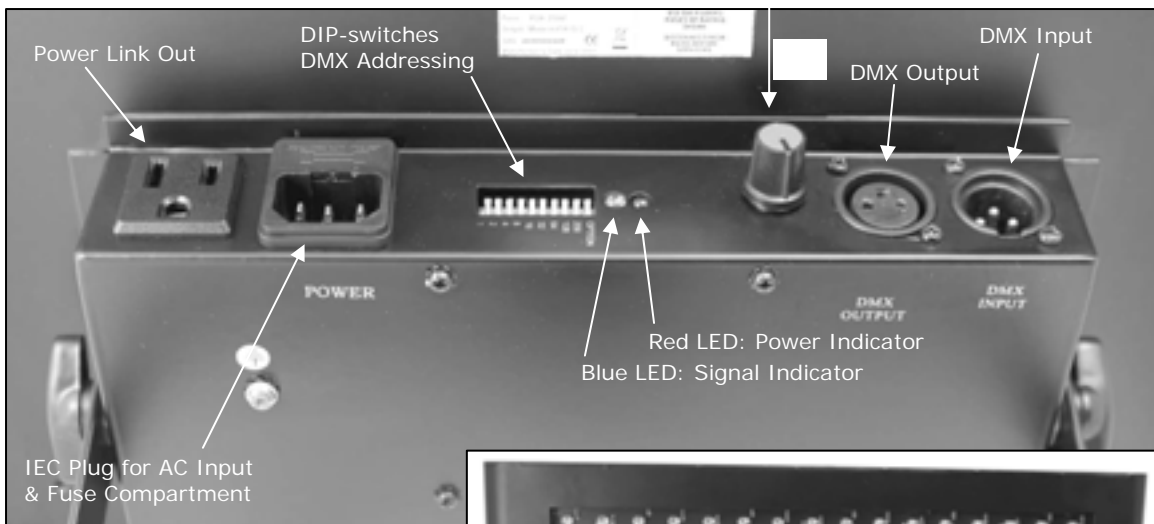
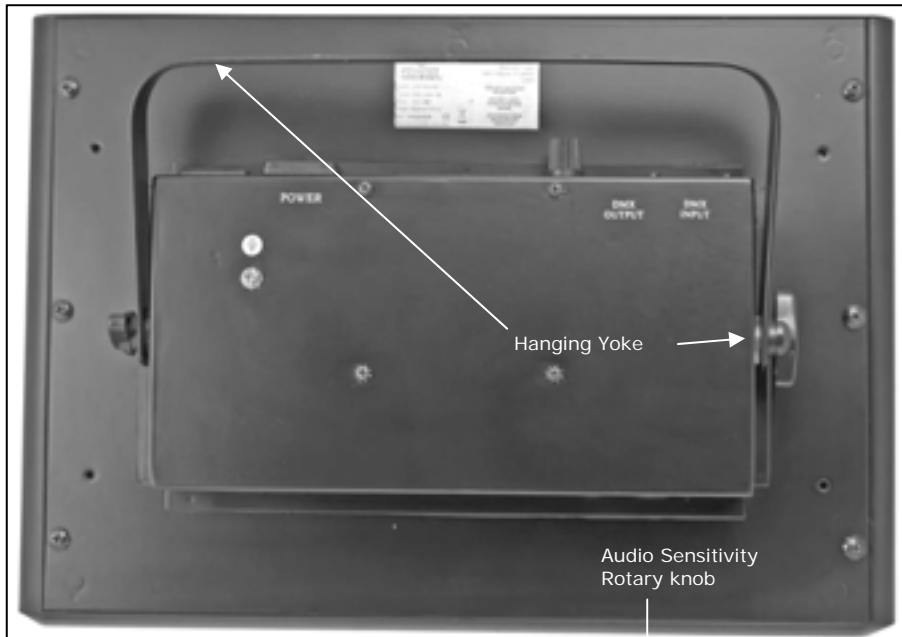

# 3. Setup

## AC Power

### Warning!

**Verify that the power requirement label on your unit matches the line voltage applied. All fixtures must be connected to circuits with a suitable Earth Ground.**

- To determine the power requirements for a particular fixture, see the label affixed to the back plate of the fixture or refer to the fixture's specifications chart.
- A fixture's listed current rating is its average current draw under normal conditions.
- All fixtures must be powered directly off a switched circuit and cannot be run off a rheostat (variable resistor) or dimmer circuit, even if the rheostat or dimmer channel is used solely for a 0% to 100% switch.
- Before applying power to a fixture, check that the source voltage matches the fixture's requirement.
- All fixtures must be connected to circuits with a suitable Earth Ground.

### Power Cable Configuration

CABLE	Pin	International	Screw Color
BROWN	Live	L	Yellow or Brass
BLUE	Neutral	N	Silver
YELLOW/GREEN	Earth	EG (Ground)	Green

## Mounting

### Orientation

This fixture can be mounted on a truss using a clamp in any position or against a flat surface using the brackets provided.

### Rigging

The fixture includes a mounting yoke to which 1 rigging clamp can be bolted and (2) Flush Mount Brackets for flush mounting to flat surfaces. You must supply your own clamp and make sure the clamp is capable of supporting the weight of this fixture. You can order C-clamps from any CHAUVET dealer or distributor.

1. Block access below the work area and use suitable and stable platform when installing or servicing fixture.
2. Align the clamp screw with the center hole on the yoke and tighten.
3. Verify the structure can hold 10 times the weight of all to-be installed fixtures.
4. Adjust the angle on the yoke arm as necessary.
5. Always use a safety cable or chain as a secondary source of attachment. The safety cable must hold 10 times the weight of the fixture. If safety cable attachment point is provided that is permanently affixed to the surface or body of the fixture, use that instead of looping through a hanging yoke/arm.

Hanging Clamp



Flush Mounting Bracket

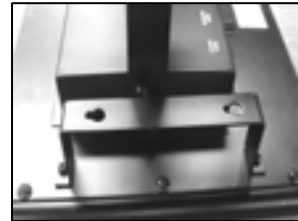

### Flush Mounting

1. Draw a screw hole template on a large piece of vellum or transparent paper for best alignment.
2. Place paper against the mounting surface and drill holes or mark the surface for drilling.
3. Hang Panel.

## Fixture Linking

You will need a serial data link to run light shows of one or more fixtures using a DMX-512 controller or to run synchronized shows on two or more fixtures set to a master/slave operating mode. The combined number of channels required by all the fixtures on a serial data link determines the number of fixtures the data link can support.

The TFX-UVLED fixtures use 3 channels of DMX control.

**Important:** Fixtures on a serial data link must be daisy chained in one single line. To comply with the EIA-485 standard no more than 32 devices should be connected on one data link. Connecting more than 32 fixtures on one serial data link without the use of a DMX optically isolated splitter may result in deterioration of the digital DMX signal.

Maximum recommended serial data link distance: 500 meters (1640 ft.)

Maximum recommended number of fixtures on a serial data link: 32 fixtures

### Data Cabling

To link fixtures together you must obtain data cables. You can purchase CHAUVET certified DMX cables directly from a dealer/distributor or construct your own cable. If you choose to create your own cable please use data-grade cables that can carry a high quality signal and are less prone to electromagnetic interference.

#### DMX Data Cable

Use a Belden© 9841 or equivalent cable which meets the specifications for EIA RS-485 applications. Standard microphone cables cannot transmit DMX data reliably over long distances. The cable will have the following characteristics:

- 2-conductor twisted pair plus a shield
- Maximum capacitance between conductors – 30 pF/ft.
- Maximum capacitance between conductor and shield – 55 pF/ft.
- Maximum resistance of 20Ω / 1000 ft.
- Nominal impedance 100 - 140Ω

#### Cable Connectors

Cabling must have a male XLR connector on one end and a female XLR connector on the other end.

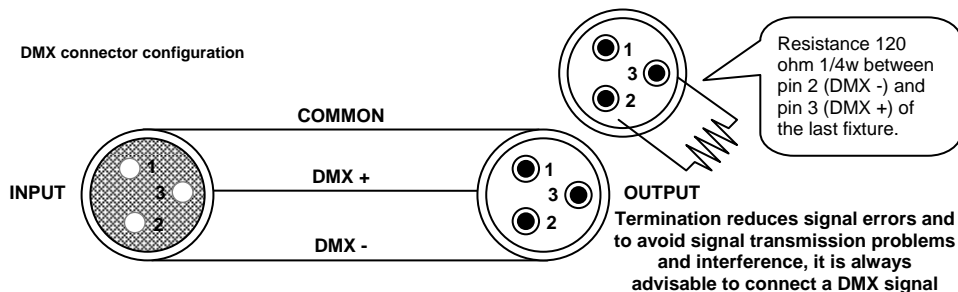

**CAUTION** Do not allow contact between the common and the fixture's chassis ground. Grounding the common can cause a ground loop and your fixture to perform erratically. Test cables with OHM meter to verify correct polarity and to make sure the pins are not grounded or shorted to the shield or each other.

### 3-Pin to 5-Pin Conversion Chart

Note! If you use a controller with a 5 pin DMX output connector, you will need to use a 5 pin to 3 pin adapter. CHAUVET Model No: DMX5M.  
The chart below details a proper cable conversion:

3 PIN TO 5 PIN CONVERSION CHART

Conductor	3 Pin Female (output)	5 Pin Male (Input)
Ground/Shield	Pin 1	Pin 1
Data ( - )signal	Pin 2	Pin 2
Data ( + ) signal	Pin 3	Pin 3
Do not use		Do not use
Do not use		Do not use

## Setting up a DMX Serial Data Link

1. Connect the (male) 3 pin connector side of the DMX cable to the output (female) 3 pin connector of the controller.
2. Connect the end of the cable coming from the controller which will have a (female) 3 pin connector to the input connector of the next fixture consisting of a (male) 3 pin connector.
3. Then, proceed to connect from the output as stated above to the input of the following fixture and so on.

#### CHAUVET Certified DMX Data Cables

Order Code	Description
DMX1.5	DMX Cable 1.5m/4.9ft
DMX4.5	DMX Cable 4.5m/14.8ft
DMX10	DMX Cable 10m/32.8ft

Universal DMX Controller

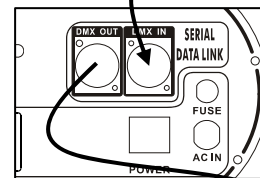
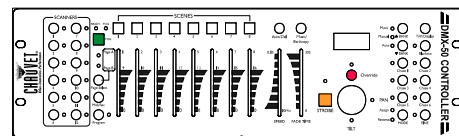

This drawing provides a general illustration of the DMX Input/Output panel of a lighting fixture.

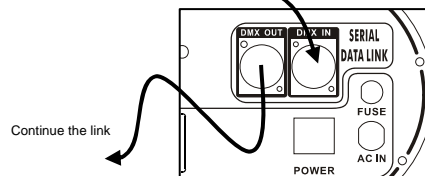

Continue the link

## Standalone/Master-Slave Fixture Linking

1. Connect the (male) 3 pin connector side of the DMX cable to the output (female) 3 pin connector of the first fixture.
2. Connect the end of the cable coming from the first fixture which will have a (female) 3 pin connector to the input connector of the next fixture consisting of a (male) 3 pin connector. Then, proceed to connect from the output as stated above to the input of the following fixture and so on.

Often, the setup for Master-Slave and Standalone operation requires that the first fixture in the chain be initialized for this purpose via either settings in the control panel or DIP-switches. Secondly the fixtures that follow may also require a slave setting. Please consult the "Operating Instructions" section in this manual for complete instructions for this type of setup and configuration.

Fixtures displayed are for illustration purpose only!

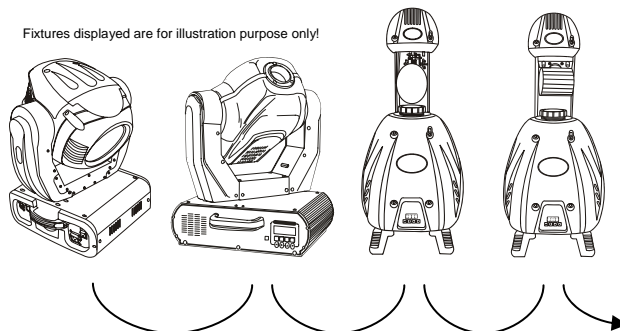

# 4. Operating Instructions

The TFX-UVLED is a DMX-512 controllable, flash UV LED panel made up of highly efficient and super bright UV LEDs. The TFX-UVLED can operate in Stand-Alone, Master/Slave and via DMX-512 control utilizing 3 channels.

## Standalone Mode

The TFX-UVLED can be operated without a DMX controller in a standalone mode. It can be operated as a single fixture or together with several other TFX-UVLED fixtures in what is called a "Master/Slave" configuration.

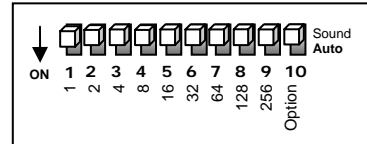

### Single-Fixture Mode

The TFX-UVLED can be set to operate independently of other fixtures or a DMX controller in either a sound-active or automatic mode. A serial data-link is not necessary for this mode of operation and it is recommended that no connection to other fixtures be made at all.

1. Simply choose from any one of 10 built-in "DIP-switch Options" from the table below.

### Master-Slave Mode

A master-slave mode setup consists of more than one fixture connected in a serial data link without the use of a controller. In a master-slave operation the slave fixtures will synchronize and will behave either identically or in a planned chase pattern to the master unit which must be the first in the serial daisy chain. A Master-Slave TFX-UVLED system can consist of an unlimited range of fixtures or at least the number stated to conform to EIA-485 standards.

### Setup

1. The TFX-UVLED sets up automatically for Master-Slave, no DIP-switch settings are required other than for selecting DIP-switch Options.
2. Connect the end of the cable coming from the first fixture which will have a (female) 3 pin connector to the **DMX IN** input connector of the Slave fixture consisting of a (male) 3 pin connector. Continue the loop from **DMX OUT** to **DMX IN**.

### Dipswitch Options

Functions	Dipswitches ( ON )	Notes & Description
Sound Active	None	Music: Sound Activated, Rotary knob sets sound sensitivity
Flash	1	Flash Speed 1
	2	Flash Speed 2
	3	Flash Speed 3
	4	Flash Speed 4
	5	Flash Speed 5
	6	Flash Speed 6
	7	Flash Speed 7
	8	Flash Speed 8
Full On	9	All LEDs full on
Preset Program	10	Preset Programs run in Automatic speed

## DMX Control Mode

The TFX-UVLED can be operated from a DMX controller. This control mode environment gives the user the greatest flexibility when it comes to customizing or creating a show by enabling the control of each individual trait of the fixture and each fixture independently.

### Configuring for DMX control

1. Connect the (male) 3 pin connector side of the DMX cable to the output (female) 3 pin connector of the controller.
2. Connect the end of the cable coming from the controller which will have a (female) 3 pin connector to the input connector of the next fixture consisting of a (male) 3 pin connector.
3. Then, proceed to connect from the DMX output as stated above to the DMX input of the following fixture and so on.
4. If you need help setting the DMX address read the section titled "Setting the DMX address" in this Chapter.

### Setting the DMX address

Each fixture requires a "start address" from 1 to 511. A fixture requiring one or more channels for control begins to read the data on the channel indicated by the start address. For example, a fixture that occupies or uses 7 channels of DMX and was addressed to start on DMX channel 100, would read data from channels: 100, 101, 102, 103, 104, 105 and 106. Choose start addresses so that the channels used do not overlap and notate the start address selected for future reference. If this is your first time, read the DMX Primer in the Appendix Section.

## Daisy Chain (Serial Data Link)

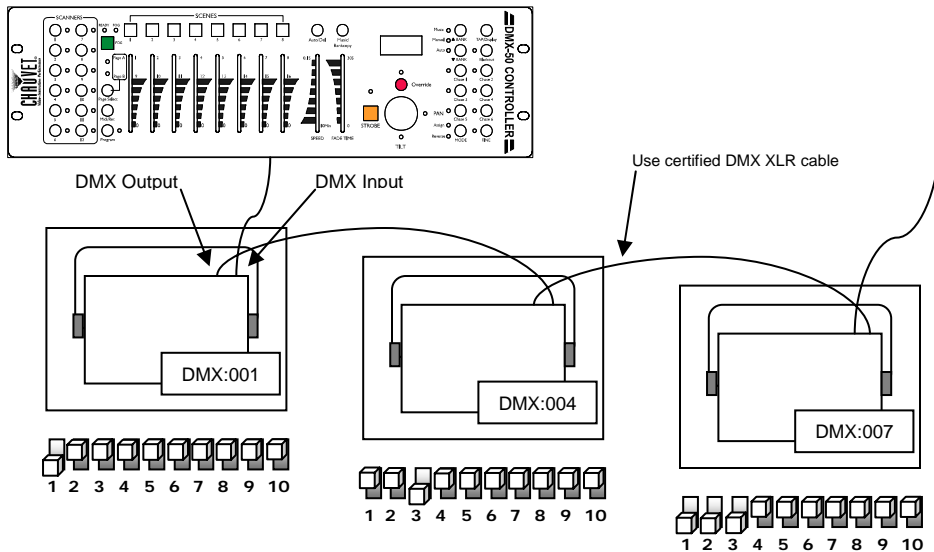

Visit the section titled; Binary & DMX DIP-switch Addressing on page 13 & Binary Addressing Quick Reference Chart on page 14 to quickly determine the binary DIP-switch settings for addressing.

# 5. Appendix

---

## DMX Primer

There are 512 channels in a DMX-512 connection. Channels may be assigned in any manner. A fixture capable of receiving DMX-512 will require one or a number of sequential channels. The user must assign a starting address on the fixture that indicates the first channel reserved in the controller. There are many different types of DMX controllable fixtures and they all may vary in the total number of channels required. Choosing a start address should be planned in advance. Channels should never overlap. If they do, this will result in erratic operation of the fixtures whose starting address is set incorrectly. You can however, control multiple fixtures of the same type using the same starting address as long as the intended result is that of unison movement or operation. In other words, the fixtures will be slaved together and all respond exactly the same.

DMX fixtures are designed to receive data through a serial Daisy Chain. A Daisy Chain connection is where the DATA OUT of one fixture connects to the DATA IN of the next fixture. The order in which the fixtures are connected is not important and has no effect on how a controller communicates to each fixture. Use an order that provides for the easiest and most direct cabling. Connect fixtures using shielded two conductor twisted pair cable with three pin XLR male to female connectors. The shield connection is pin 1, while pin 2 is Data Negative (S-) and pin 3 is Data positive (S+). CHAUVET carries 3-pin XLR DMX compliant cables, DMX-10 (33'), DMX-4.5 (15') and DMX-1.5 (5')

## Returns Procedure

Returned merchandise must be sent prepaid and in the original packing, call tags will not be issued. Package must be clearly labeled with a Return Merchandise Authorization Number (RA #). Products returned without an RA # will be refused. Call CHAUVET and request RA # prior to shipping the fixture. Be prepared to provide the model number, serial number and a brief description of the cause for the return. Be sure to properly pack fixture, any shipping damage resulting from inadequate packaging is the customer's responsibility. CHAUVET reserves the right to use its own discretion to repair or replace product(s). As a suggestion, proper UPS packing or double-boxing is always a safe method to use.

## Claims

Damage incurred in shipping is the responsibility of the shipper; therefore the damage must be reported to the carrier upon receipt of merchandise. It is the customer's responsibility to notify and submit claims with the shipper in the event that a fixture is damaged due to shipping. Any other claim for items such as missing component/part, damage not related to shipping, and concealed damage, must be made within seven (7) days of receiving merchandise.

## Maintenance

To maintain optimum performance and minimize wear, fixtures should be cleaned frequently. Usage and environment are contributing factors in determining frequency. As a general rule, fixtures should be cleaned at least twice a month. Dust build up reduces light output performance and can cause overheating. This can lead to reduced lamp life and increased mechanical wear. Be sure to power off fixture before conducting maintenance.

Unplug fixture from power. Use a vacuum or air compressor and a soft brush to remove dust collected on external vents and internal components. Clean all glass when the fixture is cold with a mild solution of glass cleaner or Isopropyl Alcohol and a soft lint free cotton cloth or lens tissue. Apply solution to the cloth or tissue and drag dirt and grime to the outside of the lens. Gently polish optical surfaces until they are free of haze and lint. Do not touch the lamp glass when cleaning fixture. Oil and dirt can cause damage and premature aging of the lamp. In the event that the lamp is touched or becomes dirty, clean the lamps with an alcohol wipe.

The cleaning of internal and external optical lenses and/or mirrors must be carried out periodically to optimize light output. Cleaning frequency depends on the environment in which the fixture operates: damp, smoky or particularly dirty surrounding can cause greater accumulation of dirt on the unit's optics. Clean with soft cloth using normal glass cleaning fluid. - Always dry the parts carefully. - Clean the external optics at least every 20 days. Clean the internal optics at least every 30/60 days.

## Binary & DMX DIP-switch Addressing

Each DIP-switch has an associated value. Adding the value of each switch in the ON position will provide the final address. Determining which switches to toggle ON given a specific desired address or value can be accomplished in the following manner. By subtracting the largest switch value possible from the selected start address which does not cause a negative number.

Alternatively, using the "Binary Addressing Quick Reference Chart" in the Appendix section of this manual, you can go directly to DIP-switch settings associated with all 512 values available.

<b>EXAMPLE ADDRESS</b>																								
<b>Address 10</b>																								
<p>Pin # 4 = 8 Pin # 2 = 2 Total = 10</p>																								
<b>Address 24</b>																								
<p>Pin # 5 = 16 Pin # 4 = 8 Total = 24</p>																								
<p><b>Resolving address using simple math.</b> <b>Address 233</b></p>	<p>233 – (128) = 105, Turn ON Dip # 8 105 – (64) = 41, Turn ON Dip # 7 41 – (32) = 9, Turn ON Dip # 6 9 – (8) = 1, Turn ON Dip # 4 1 – (1) = 0, Turn ON Dip # 1</p> <p>You will most likely use the first available number which maybe number 1. This number was selected for tutorial purposes.</p>	<table border="1"> <thead> <tr> <th>DIP SWITCH</th> <th>(DMX VALUE)</th> </tr> </thead> <tbody> <tr><td>1</td><td>1</td></tr> <tr><td>2</td><td>2</td></tr> <tr><td>3</td><td>4</td></tr> <tr><td>4</td><td>8</td></tr> <tr><td>5</td><td>16</td></tr> <tr><td>6</td><td>32</td></tr> <tr><td>7</td><td>64</td></tr> <tr><td>8</td><td>128</td></tr> <tr><td>9</td><td>256</td></tr> <tr><td>10</td><td></td></tr> </tbody> </table>	DIP SWITCH	(DMX VALUE)	1	1	2	2	3	4	4	8	5	16	6	32	7	64	8	128	9	256	10	
DIP SWITCH	(DMX VALUE)																							
1	1																							
2	2																							
3	4																							
4	8																							
5	16																							
6	32																							
7	64																							
8	128																							
9	256																							
10																								

# Binary Addressing Quick Reference Chart

## DMX & Binary Address Quick Reference Chart

DIP-switch Position

DMX DIP-SWITCH SET					#9	0	0	0	0	0	0	0	0	1	1	1	1	1	1	1	
0=OFF					#8	0	0	0	0	1	1	1	1	0	0	0	0	1	1	1	1
1=ON					#7	0	0	1	1	0	0	1	1	0	0	1	1	0	0	1	1
X=OFF or ON					#6	0	1	0	1	0	1	0	1	0	1	0	1	0	1	0	1
#1	#2	#3	#4	#5																	
0	0	0	0	0		32	64	96	128	160	192	224	256	288	320	352	384	416	448	480	
1	0	0	0	0	1	33	65	97	129	161	193	225	257	289	321	353	385	417	449	481	
0	1	0	0	0	2	34	66	98	130	162	194	226	258	290	322	354	386	418	450	482	
1	1	0	0	0	3	35	67	99	131	163	195	227	259	291	323	355	387	419	451	483	
0	0	1	0	0	4	36	68	100	132	164	196	228	260	292	324	356	388	420	452	484	
1	0	1	0	0	5	37	69	101	133	165	197	229	261	293	325	357	389	421	453	485	
0	1	1	0	0	6	38	70	102	134	166	198	230	262	294	326	358	390	422	454	486	
1	1	1	0	0	7	39	71	103	135	167	199	231	263	295	327	359	391	423	455	487	
0	0	0	1	0	8	40	72	104	136	168	200	232	264	296	328	360	392	424	456	488	
1	0	0	1	0	9	41	73	105	137	169	201	233	265	297	329	361	393	425	457	489	
0	1	0	1	0	10	42	74	106	138	170	202	234	266	298	330	362	394	426	458	490	
1	1	0	1	0	11	43	75	107	139	171	203	235	267	299	331	363	395	427	459	491	
0	0	1	1	0	12	44	76	108	140	172	204	236	268	300	332	364	396	428	460	492	
1	0	1	1	0	13	45	77	109	141	173	205	237	269	301	333	365	397	429	461	493	
0	1	1	1	0	14	46	78	110	142	174	206	238	270	302	334	366	398	430	462	494	
1	1	1	1	0	15	47	79	111	143	175	207	239	271	303	335	367	399	431	463	495	
0	0	0	0	1	16	48	80	112	144	176	208	240	272	304	336	368	400	432	464	496	
1	0	0	0	1	17	49	81	113	145	177	209	241	273	305	337	369	401	433	465	497	
0	1	0	0	1	18	50	82	114	146	178	210	242	274	306	338	370	402	434	466	498	
1	1	0	0	1	19	51	83	115	147	179	211	243	275	307	339	371	403	435	467	499	
0	0	1	0	1	20	52	84	116	148	180	212	244	276	308	340	372	404	436	468	500	
1	0	1	0	1	21	53	85	117	149	181	213	245	277	309	341	373	405	437	469	501	
0	1	1	0	1	22	54	86	118	150	182	214	246	278	310	342	374	406	438	470	502	
1	1	1	0	1	23	55	87	119	151	183	215	247	279	311	343	375	407	439	471	503	
0	0	0	1	1	24	56	88	120	152	184	216	248	280	312	344	376	408	440	472	504	
1	0	0	1	1	25	57	89	121	153	185	217	249	281	313	345	377	409	441	473	505	
0	1	0	1	1	26	58	90	122	154	186	218	250	282	314	346	378	410	442	474	506	
1	1	0	1	1	27	59	91	123	155	187	219	251	283	315	347	379	411	443	475	507	
0	0	1	1	1	28	60	92	124	156	188	220	252	284	316	348	380	412	444	476	508	
1	0	1	1	1	29	61	93	125	157	189	221	253	285	317	349	381	413	445	477	509	
0	1	1	1	1	30	62	94	126	158	190	222	254	286	318	350	382	414	446	478	510	
1	1	1	1	1	31	63	95	127	159	191	223	255	287	319	351	383	415	447	479	511	

DIP-switch Position

DMX Address

# DMX Channel Values

## NOTE!

Please read all instructions carefully on fixture DMX control mode and addressing.

DMX channels 2, and 3 functions are determined by the current settings of channel 1. For example, while Channel 1 is set between 000 and 029 the following conditions will apply;

- Channel 2 will control Dimming Intensity from 0% to 100%
- Channel 3 will control Dimming Intensity from 100% to 0%

Channel	Value	Function	Ch 2	Ch 3
1	000 ⇔ 029	<b>Dimmer Mode</b>	<b>Flash Speed</b> 0% ⇔ 100%	<b>Intensity</b> 100% ⇔ 0%
	030 ⇔ 059	<b>Program 1</b>	<b>Speed</b> Slow ⇔ Fast	
	060 ⇔ 089	<b>Program 2</b>		
	090 ⇔ 119	<b>Program 3</b>		
	120 ⇔ 149	<b>Program 4</b>		
	150 ⇔ 179	<b>Program 5</b>		
	180 ⇔ 209	<b>Program 6</b>		
	210 ⇔ 255	<b>Sound</b>		

# Technical Specifications

## WEIGHT & DIMENSIONS

Length..... 355.6 mm (14.0 in)  
 Width ..... 247.65 mm (9.75 in)  
 Height ..... 165.1 mm (6.5 in)  
 Weight ..... 2.22 Kgs (4.9 lbs)  
 Master Pack..... (4 pcs) 12.84 Kgs (28.3 lbs)

## POWER

Operating Voltage ..... 90V ~ 240V 50/60 Hz  
 AC input..... IEC 60320 C14  
 Current draw..... (peak <12W @ 120V), (inrush <24W @ 120V)

## FUSE

Main..... 20mm Glass 2A Fast Blow

## LED

Quantity ..... 192 Total, (UV)

## CONTROL & PROGRAMMING

Data input ..... locking 3-pin XLR male socket  
 Data output..... locking 3-pin XLR female socket  
 Data pin configuration ..... pin 1 shield, pin 2 (-), pin 3 (+)  
 Protocols..... DMX-512 USITT  
 DMX Channels ..... 3

## ORDERING INFORMATION

LED Shadow™ ..... TFX-UVLED

# Technical Support

Address: Service Dept.  
 3000 N 29th Ct, Hollywood, FL 33020 (U.S.A.)  
 Support (Email): [tech@chauvetlighting.com](mailto:tech@chauvetlighting.com)  
 Telephone: (954) 929-1115 - (Press 4)  
 Fax: (954) 929-5560 - (Attention: Service)  
 Website: <http://www.chauvetlighting.com>